

m o o o i

Aldora Vis a Vis

CRISTINA CELESTINO



The Aldora Vis a Vis, designed by Cristina Celestino, adds a touch of natural charm to any commercial or private space. The sculptural backrests are inspired by Milanese decadence and graceful calla lilies. Its dual-sided design offers functional elegance, making it perfect as a freestanding seater. Discover versatility with left/right setups and choose from an array of fabrics and leathers for a personalised touch. Aldora Vis a Vis will invite conversations, engage in style, and elevate any space. The Aldora Vis a Vis is also available as a sofa and chaise longue. Configure the Aldora Vis a Vis to your personal tastes with the online configurator. Choose from a wide selection of fabrics and leathers and discover what it looks like with our AR tool.

Detailing

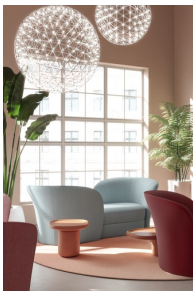

Aldora Vis a Vis is perfect for offices and waiting areas. This dual-sided, freestanding design offers functional elegance.

Aldora Vis a Vis / Left

Dimensions

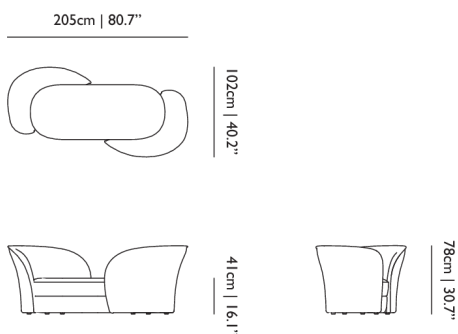

Product

WIDTH 205cm | 80.7"
HEIGHT 78cm | 30.7"
DEPTH 102cm | 40.2"
WEIGHT NETTO 46kg | 101.4lbs

Packaging

WIDTH 85cm | 33.5"
HEIGHT 84cm | 33.1"
CUBAGE 1.48m³ | 52.19ft³
LENGTH 207cm | 81.5"
WEIGHT 59.5kg | 131.17lbs

Technical

MATERIAL

Wood and steel frame, foam over steel springs

WEIGHT CAPACITY

110kg | 242.51lbs

SEATING CAPACITY

2

Aldora Vis a Vis / Right

Dimensions

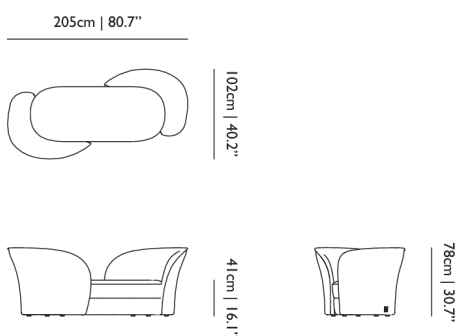

Product

WIDTH 205cm | 80.7"
HEIGHT 78cm | 30.7"
DEPTH 102cm | 40.2"
WEIGHT NETTO 46kg | 101.4lbs

Packaging

WIDTH 85cm | 33.5"
HEIGHT 84cm | 33.1"
CUBAGE 1.48m³ | 52.19ft³
LENGTH 207cm | 81.5"
WEIGHT 59.5kg | 131.17lbs

Technical

MATERIAL

Wood and steel frame, foam over steel springs

WEIGHT CAPACITY

110kg | 242.51lbs

SEATING CAPACITY

2

Upholstery

Abbracci (available in 6 colours)

**COMPOSITION**

100% PES

ABRASION50000 martindale
lightfastness 3 - 4
pilling 5**FIRE RESISTANCE**BS 5852 - Ignition source
0 (Cigarette)
BS 5852 - Ignition source
1 (Match flame equivalent)
EN 1021-1 (Cigarette)
EN 1021-2 (Match)
TB 117-2013

Arda (available in 12 colours)

**ABRASION**50000 martindale
lightfastness 5 - 6
pilling 4 - 5**FIRE RESISTANCE**BS 5852 - Ignition source
0 (Cigarette)
BS 5852 - Ignition source
5 (Crib 5)
BS 5852 - Ignition source
1 (Match flame equivalent)
EN 1021-1 (Cigarette)
EN 1021-2 (Match)
TB 117-2013
EU Ecolabel

Autumn (available in 14 colours)

Boucle (available in 5 colours)

**COMPOSITION**43% CO, 14% PA, 12% CV,
3% PES, 28% PAN**ABRASION**40000 martindale
lightfastness 4 - 6
pilling 4 - 5**FIRE RESISTANCE**EN 1021-1 (Cigarette)
EN 1021-2 (Match)

Divina 3 (available in 56 colours)

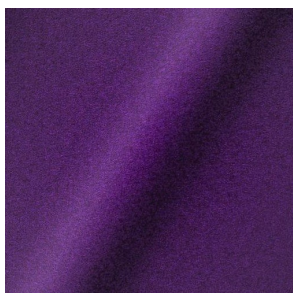

COMPOSITION

100% WO

ABRASION

45000 martindale
lightfastness 7
pilling 3

FIRE RESISTANCE

BS 5852 - Ignition source
0 (Cigarette)
BS 5852 - Ignition source
5 (Crib 5)
BS 5852 - Ignition source
1 (Match flame equivalent)
EN 1021-1 (Cigarette)
EN 1021-2 (Match)
TB 117-2013
EU Ecolabel

Divina MD (available in 27 colours)



COMPOSITION

100% WO

ABRASION

45000 martindale
lightfastness 6
pilling 3

FIRE RESISTANCE

BS 5852 - Ignition source
0 (Cigarette)
BS 5852 - Ignition source
5 (Crib 5)
BS 5852 - Ignition source
1 (Match flame equivalent)
EN 1021-1 (Cigarette)
EN 1021-2 (Match)
EU Ecolabel

Divina Melange 3 (available in 49 colours)

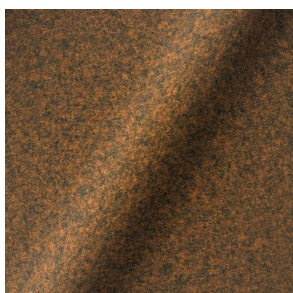

COMPOSITION

100% WO

ABRASION

45000 martindale
lightfastness 6 - 7
pilling 3

FIRE RESISTANCE

BS 5852 - Ignition source
0 (Cigarette)
BS 5852 - Ignition source
5 (Crib 5)
BS 5852 - Ignition source
1 (Match flame equivalent)
EN 1021-1 (Cigarette)
EN 1021-2 (Match)
TB 117-2013
EU Ecolabel

Bearded Leopard (available in 3 colours)

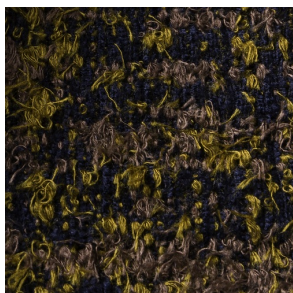

COMPOSITION

77% CV, 15% PES, 7% CO,
1% PA

ABRASION

15000 martindale
lightfastness 4 - 6
pilling 4

Blushing Sloth (available in 1 colour)

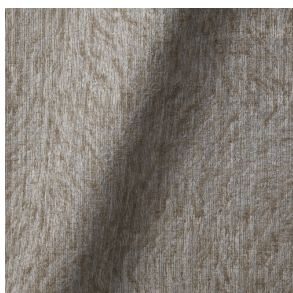

Calligraphy Bird (available in 4 colours)

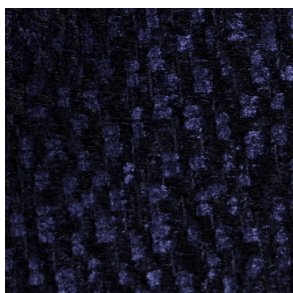

COMPOSITION

64% CV, 21% PES, 15%
CO

ABRASION

50000 martindale
lightfastness 4 - 6
pilling 5

Dandelion Cranes (available in 1 colour)



Dodo Pavone (available in 3 colours)



COMPOSITION

12% CO, 88% PES

ABRASION

40000 martindale

lightfastness 5

pilling 4 - 5

Golden Tiger (available in 1 colours)



Memento Moooi Medley (available in 1 colours)



COMPOSITION

100% PES

ABRASION

50000 martindale

lightfastness 4 - 6

pilling 5

FIRE RESISTANCE

EN 1021-1 (Cigarette)

EN 1021-2 (Match)

TB 117-2013

Menagerie of Extinct Animals (available in 2 colours)



COMPOSITION

100% PES

ABRASION

50000 martindale

lightfastness 4 - 6

pilling 5

FIRE RESISTANCE

EN 1021-1 (Cigarette)

EN 1021-2 (Match)

TB 117-2013

Queen Cobra (available in 1 colours)



Rendezvous Tokyo Blue (available in 1 colours)



COMPOSITION

100% PES

ABRASION

50000 martindale
lightfastness 4 - 6
pilling 5

Blushing Sloth Melange Mohair (available in 1 colours)



COMPOSITION

85% WV, 15% WM

ABRASION

15000 martindale
lightfastness 4 - 6
pilling 2 - 3

Blushing Sloth Woolly Mohair (available in 1 colours)



COMPOSITION

24% PES, 15% PA, 8% CO,
24% WM, 29% WV

ABRASION

40000 martindale
lightfastness 4 - 6
pilling 3 - 4

Fiord 2 (available in 39 colours)



COMPOSITION

92% WV, 8% PA

ABRASION

60000 martindale
lightfastness 6
pilling 4 - 5

FIRE RESISTANCE

EN 1021-1 (Cigarette)
EN 1021-2 (Match)
BS 5852 - Ignition source
0 (Cigarette)
BS 5852 - Ignition source
1 (Match flame equivalent)

Guest (available in 13 colours)

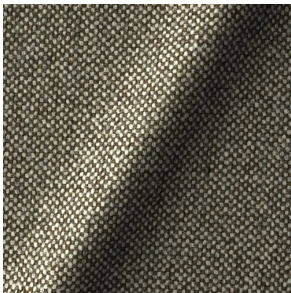

COMPOSITION

30% CV, 70% WV

ABRASION

100000 martindale
lightfastness 7
pilling 3 - 4

FIRE RESISTANCE

BS 5852 - Ignition source
0 (Cigarette)
BS 5852 - Ignition source
5 (Crib 5)
BS 5852 - Ignition source
1 (Match flame equivalent)
EN 1021-1 (Cigarette)
EN 1021-2 (Match)
TB 117-2013
EU Ecolabel

Justo (available in 11 colours)

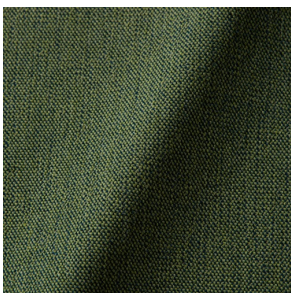

COMPOSITION

15% CO, 35% PC, 10% PA,
40% CV

ABRASION

50000 martindale
lightfastness 5
pilling 4

FIRE RESISTANCE

EN 1021-1 (Cigarette)
EN 1021-2 (Match)
TB 117-2013

Liscio (available in 6 colours)



COMPOSITION

35% WO, 35% CV, 21%
CO, 9% PA

ABRASION

30000 martindale
lightfastness 4 - 6
pilling 4

FIRE RESISTANCE

TB 117-2013

Mosaic 2 (available in 15 colours)

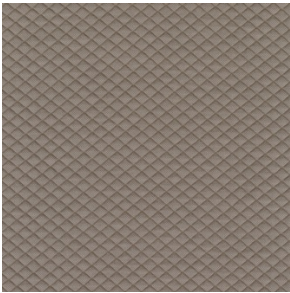

COMPOSITION

58% PES, 27% WV, 9% PA,
6% EA

ABRASION

100000 martindale
lightfastness 6 - 7
pilling 4 - 5

Palette (available in 12 colours)

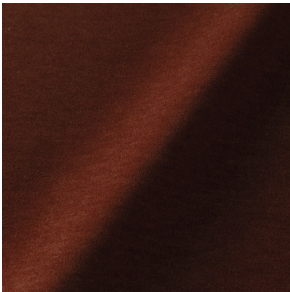

COMPOSITION

42% CO, 29% WO, 29%
TL

ABRASION

45000 martindale
lightfastness 4 - 5
pilling 3 - 3

FIRE RESISTANCE

BS 5852 - Ignition source
0 (Cigarette)
TB 117-2013
BS 5852 - Ignition source
5 (Crib 5)

Reflect (available in 35 colours)

Remix 3 (available in 54 colours)



COMPOSITION

10% PA, 90% WV

ABRASION

100000 martindale
lightfastness 5
pilling 4

Savanne (available in 3 colours)

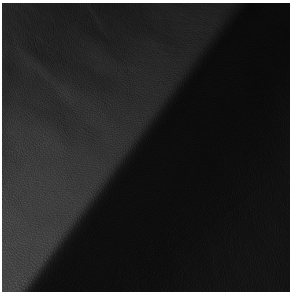

FIRE RESISTANCE
EN 1021-1 (Cigarette)
EN 1021-2 (Match)
TB 117-2013
OEKO-TEX

Shade (available in 5 colours)

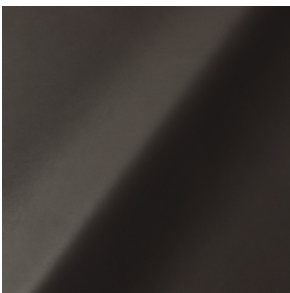

ABRASION
lightfastness 3 - 4

FIRE RESISTANCE
EN 1021-1 (Cigarette)
EN 1021-2 (Match)
TB 117-2013

Solis (available in 9 colours)



COMPOSITION
60% WO, 30% PES, 2%
PA, 3% PC

ABRASION
40000 martindale
lightfastness 5
pilling 3 - 4

FIRE RESISTANCE
EN 1021-1 (Cigarette)
EN 1021-2 (Match)
TB 117-2013

Spectrum (available in 11 colours)

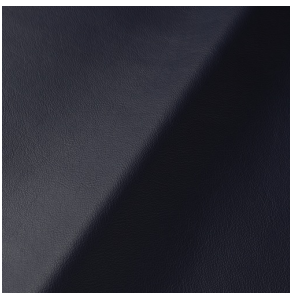

ABRASION
lightfastness 6 - 6

FIRE RESISTANCE
EN 1021-1 (Cigarette)
EN 1021-2 (Match)
TB 117-2013
OEKO-TEX

Sprinkles (available in 23 colours)

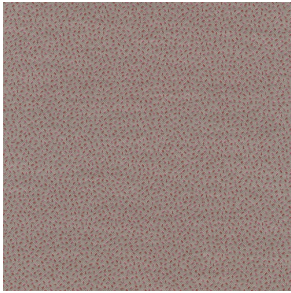

ABRASION

80000 martindale
lightfastness 7
pilling 4

FIRE RESISTANCE

EU Ecolabel
BS 5852 - Ignition source
0 (Cigarette)
BS 5852 - Ignition source
5 (Crib 5)
BS 5852 - Ignition source
1 (Match flame equivalent)
EN 1021-1 (Cigarette)
EN 1021-2 (Match)
TB 117-2013

Steelcut Trio 3 (available in 54 colours)

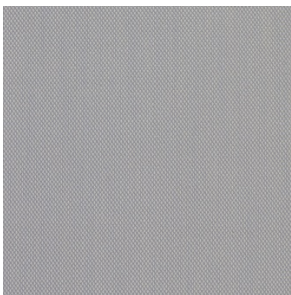

COMPOSITION

90% WV, 10% PA

ABRASION

100000 martindale
lightfastness 5
pilling 4

FIRE RESISTANCE

BS 5852 - Ignition source
0 (Cigarette)
BS 5852 - Ignition source
1 (Match flame equivalent)
EN 1021-1 (Cigarette)
EN 1021-2 (Match)
EU Ecolabel

Ultra (available in 6 colours)

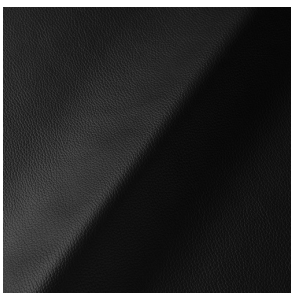

ABRASION

lightfastness 6 - 7

FIRE RESISTANCE

EN 1021-1 (Cigarette)
EN 1021-2 (Match)
TB 117-2013
ANSI/BIFMA M7.1 (Total
Volatile Organic
Compounds)

Vesper (available in 9 colours)



COMPOSITION

10% CO, 40% LI, 10% PA,
10% PES, 30% CV

ABRASION

40000 martindale
lightfastness 5
pilling 4

FIRE RESISTANCE

EN 1021-1 (Cigarette)
EN 1021-2 (Match)
TB 117-2013
